



# 4040XP Series



The 4040XP is LCN's most durable and flexible heavy duty closer designed for institutional and other demanding high traffic applications.

## Features

<b>Certifications</b>	Grade 1 - ANSI A156.4, UL 10C, ADA, 100 hour salt spray, meets BAA - Buy American Act
<b>Body construction</b>	<ul style="list-style-type: none"> <li>Cast iron body</li> <li>Full complement bearing</li> <li>1 1/2" diameter piston</li> <li>Double heat treated pinion journal</li> </ul>
<b>Fluid</b>	All weather liquid X fluid
<b>Handing</b>	Non-handed
<b>Templating</b>	Peel-n-Stick templates - 2 1/4" x 5" mounting hole pattern
<b>Size</b>	Adjustable spring size 1-6, includes patented green dial
<b>Warranty</b>	30 years

<b>Cover</b>	<ul style="list-style-type: none"> <li>Plastic Cover (PC), standard</li> <li>Metal Cover (MC), optional</li> </ul>
<b>Fasteners</b>	Self reaming and tapping screws (SRT)
<b>Mounting</b>	Hinge (pull side), top jamb (push side), parallel arm (push side)
<b>Arms</b>	Regular arm
<b>Finishes/colors/ powder coat</b>	<ul style="list-style-type: none"> <li>689 Aluminum</li> <li>690 Statuary bronze</li> <li>691 Light bronze</li> <li>693 Black</li> <li>695 Dark bronze</li> <li>696 Brass</li> <li>Custom colors optional</li> </ul>
	<ul style="list-style-type: none"> <li>Optional SRI primer - powder coat only</li> <li>Optional plated finishes</li> </ul>

### Special templates

Customized installation templates or products may be available to solve non-standard applications. Contact LCN Product Support for assistance.

Mounting	Finish	Cover	Cylinder	Arm function*
Hinge (pull) side	Plastic	Non-handed	120°	Regular (double)
Top jamb (pull)	Metal	Non-sized	120°	Standard (single)
Top jamb (push)		Accessibility	180°	Hold Open
Parallel arm		Delay Action***	110°	Fusible Link
Stop face		CYLAVB**	110°	EDA/HEDA
Powder coat				CUSH/HCUSH
Plated				SCUSH/SHCUSH
				Double Egress

- Available
- Not available

♿ Closer available with less than 5.0 lbs. opening force on 36" door.  
 \* Maximum opening/hold open point with standard template.  
 \*\* Advanced Variable Back Check.  
 \*\*\* Delay feature incorporates standard 4040 cylinder (not XP).

## Mounting details

### Parallel arm (push) side mounting

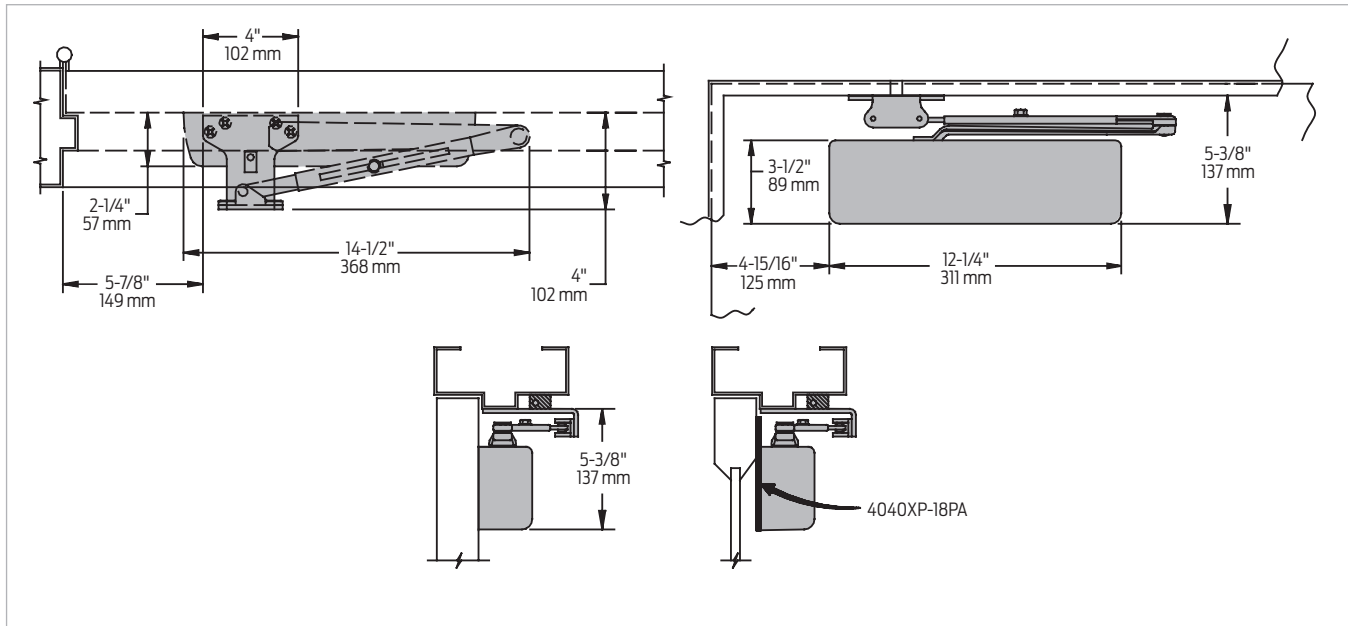

Butt hinges	Should not exceed 5" (127 mm) in width
Auxiliary stop	Recommended at hold open point, where the door cannot swing 180°, or where Cush-n-Stop Arm is not used
Reveal	Should not exceed 7/32" (6 mm)
Top rail	Less than 5 3/8" (137 mm) measured from the stop requires plate, 4040XP-18PA. Plate requires 2" (51 mm) minimum from the stop.
Head frame	Flush or rabbeted requires PA shoe adapter, 4040XP-419
Stop width	Minimum 1" (25 mm). CUSH arm requires minimum 1 1/2" (38 mm)
Blade stop	Clearance requires 1/2" (13mm) blade stop spacer, 4040XP-61
Clearance	<ul style="list-style-type: none"> <li>4040XP-62PA shoe is 4" (102 mm) from door face</li> <li>EDA shoe projects 5 1/2" (140 mm) from door face</li> <li>CUSH shoe projects 6" (152 mm) from door face</li> </ul>
Delay action	<ul style="list-style-type: none"> <li>Incorporates standard 4041 cylinder, without XP cylinder</li> <li>Delays closing from 120° to 70°</li> <li>Delay time adjustable up to approximately 1 minute</li> </ul>
Maximum opening	<ul style="list-style-type: none"> <li>180° opening/hold open points with all except CUSH arms</li> <li>110° opening/hold open with CUSH arms</li> </ul>

Notes:

- Optional mounting requires PA shoe, 4040XP-62PA for regular or Hold Open Arms
- Add prefix "P" to closer description (eg. P4040XP)
- P4040XP closer includes 4040XP-201 fifth hole spacer to support PA shoe

## Accessories

### Cylinders

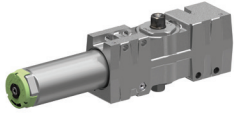

**4040XP-3071  
Cast iron cylinder  
assembly (CYL)**

- Non-handed
- Heavy duty

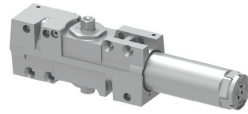

**4041-3071 DEL  
Delay Action Cylinder  
(CYLDEL)**

- Used for delayed action closing
- Non-handed
- Heavy duty

### Covers

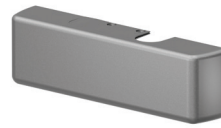

**4040XP-72  
Plastic Cover (PC)**

- Non-handed
- Includes 4040XP-54 snap-on cover clip

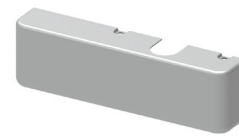

**4040XP-72MC  
Metal Cover (MC)**

- Handed
- Required for plated finishes and custom powder coat finishes
- Optional

### Arms



**4040XP-3077  
Regular Arm (REGARM)**

- Non-handed
- Mounts pull side or top jamb with shallow reveal P4041 closer includes PA shoe, 4040XP-62PA required for parallel arm mounting



**4040XP-3077L  
Long Arm (LONG)**

- Non-handed
- Includes long rod and shoe, 4040XP-79LR for top jamb mount
- Optional



**4040XP-3077ELR  
Extra Long Arm (XLONG)**

- Non-handed
- Includes extra long rod and shoe, 4040XP-79ELR for top jamb mount with deep reveal
- Optional



**4040XP-3049  
Hold Open Arm (H)**

- Non-handed
- Mounts pull side or top jamb with shallow reveal, hold open adjustable shoe
- 4040XP closer includes 4040XP-62PA shoe required for parallel arm mounting
- Optional



**4040XP-3049L  
Hold Open Long Arm (HLONG)**

- Non-handed
- Includes long head and tube, 4040XP-3048L for top jamb mount
- Optional



**4040XP-3077EDA  
Extra Duty Arm (EDA)**

- Non-handed
- Features forged, solid steel main and forearm for potentially abusive installations
- Optional



**4040XP-3049EDA  
Hold Open Extra Duty Arm (HEDA)**

- Handed
- Parallel arm features forged, solid steel main and forearm for potentially abusive installations
- Hold open function is adjusted at the shoe
- Optional



**4040XP-3077EDA/62G  
Extra Duty Arm with 62G Thick  
Hub Shoe (EDAW62G)**

- Non-handed
- Features forged, solid steel main and forearm for potentially abusive installations
- 62G shoe provides additional blade stop clearance
- Optional



**4040XP-3049EDA/62G  
Hold Open Extra Duty arm with 62G  
Thick Hub Shoe (HEDA62G)**

- Handed
- Features forged, solid steel main and forearm for potentially abusive installations
- 62G shoe provides additional blade stop clearance; hold open function is adjusted at the shoe
- Optional



**4040XP-3077CNS  
Cush-n-Stop Arm (CUSH)**

- Non-handed
- Features solid forged steel main arm and forearm with stop in soffit shoe.
- Optional



**4040XP-3049CNS  
Hold Open Cush-n-Stop Arm  
(HCUSH)**

- Non-handed
- Hold open function with templated stop/hold open points
- Handle controls hold open function
- Optional

## Accessories

### Arms (cont.)



- 4040XP-3077SCNS  
Spring Cush-n-Stop Arm (SCUSH)**
- Non-handed
  - For potentially abusive applications features solid forged steel main arm and forearm with spring loaded stop in the soffit shoe
  - Optional



- 4040XP-3049SCNS  
Spring Hold Open Cush-n-Stop Arm (SHCUSH)**
- Non-handed
  - For potentially abusive applications features solid forged steel main arm and forearm with spring loaded stop in the soffit shoe
  - Handle controls hold open function
  - Optional

### Installation accessories



- 4040XP-18  
Plate**
- Required for hinge side mount where top rail is less than 3 3/4" (95 mm)
  - Requires minimum 2" (51 mm) minimum top rail



- 4040XP-18G  
Plate**
- Locates top jamb mounted closer flush with top of head frame face in flush ceiling condition
  - Requires 1 3/4" (44 mm) minimum head frame



- 4040XP-18TJ  
Plate**
- Centers top jamb mounted closer vertically on head frame where face is less than 3 1/2" (89 mm). Plate requires 1 3/4" (44 mm) minimum head frame

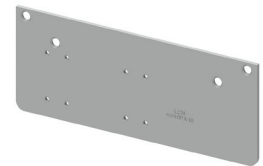

- 4040XP-18PA  
Plate**
- Required for parallel arm mounting where top rail is less than 5 1/2" (140 mm), measured from the stop
  - Requires 2" (51 mm) minimum top rail



- 4040XP-62PA  
PA shoe**
- Required for parallel arm mounting



- 4040XP-30  
CUSH shoe support**
- Provides anchorage for fifth screw used with CUSH arms, where reveal is less than 3 1/16" (78 mm)
  - Optional

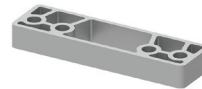

- 4040XP-61  
Blade stop spacer**
- Required to lower parallel arm shoe to clear 1/2" (13 mm) blade stop
  - Optional



- 4040XP-419  
PA flush panel adapter**
- Provides horizontal mounting surface for parallel arm shoe on single rabbeted or flush frame
  - Optional



- 4040XP-62A  
Auxiliary shoe**
- Requires a top rail of 7" (178 mm)
  - Shoe replaces -62PA for parallel arm mounting of regular arm with overhead holder/stop
  - Optional



- 4040XP-54  
Snap-on cover clip**
- Used to secure 4040XP-72 plastic cover to cylinder body

Introduction  
Product selection guide  
4010/4010T Series  
4020/4020T Series  
4030/4030T Series  
4040XP/4040XPT Series  
4050A/4050AT Series  
4110/4110T Series  
4000T Series

## Ordering information

### How-to-order 4040XP Series closers

#### 1. Select finish

- Standard powder coat \_\_\_\_\_  
Aluminum (689), Dark Bronze (695), Statuary Bronze (690), Light Bronze (691), Black (693), or Brass (696)

#### Closer options

##### Cylinder

- Delay Action Cylinder (CYLDEL)

##### Cover

- Metal (specify right or left hand)(MC)

##### Finish

- Custom powder coat (RAL) \_\_\_\_\_  
(handed metal cover required)
- Plated finish, US \_\_\_\_\_  
(handed metal cover required)
- SRI primer  
(use with powder coat finishes only)

##### Arm

- Regular Arm (REGARM)
- Regular Arm with Parallel Arm Bracket (RWPA)
- Regular Arm with 62A Auxiliary Shoe (RW62A)
- Long Arm (LONG)
- Extra Long Arm (XLONG)
- Hold Open Arm (H)

- Hold Open with Parallel Arm Bracket (HWPB)
- Hold Open Long Arm (HLONG)
- Extra Duty Arm (EDA)
- Extra Duty Arm with 62G Thick Hub Shoe (EDAW62G)
- Hold Open Extra Duty Arm (HEDA)
- Cush-n-Stop Arm (CUSH)
- Hold Open Cush-n-Stop Arm (HCUSH)
- Spring Cush-n-Stop Arm (SCUSH)
- Spring Hold Open Cush-n-Stop Arm (SHCUSH)

##### Optional screw packs

- Through Bolt<sup>1</sup> Self Reaming and Tapping Screws (TBSRT)
- Wood and Machine Screws (WMS)
- Through Bolt<sup>1</sup> Wood and Machine Screws (TBWMS)
- Torx Machine Screws (TORX)

- Through Bolt<sup>1</sup> and Torx Machine Screws (TBTRX)

##### Installation accessories

- Plate, 4040XP-18
- Plate, 4040XP-18TJ
- Plate, 4040XP-18G
- Plate, 4030-18PA
- CUSH shoe support, 4040XP-30
- Blade stop spacer, 4040XP-61
- Auxiliary shoe, 4040XP-62A
- PA flush panel adapter, 4040XP-419

##### Special template

- ST- \_\_\_\_\_

1. Specify door thickness if other than 1 3/4".

### Table of sizes

- 4040XP cylinders are adjustable from size 1 through size 6 and is shipped set to size 3
- Closing power of 4040XP Series closers may be adjusted 50%

#### Exterior (and vestibule) door width



#### Interior door width



➔ Indicates recommended range of door width for closer size.  
\* Adjustable Size 1 thru 5.

### Closer will be shipped with:

- Standard cylinder
- Standard cover
- Regular arm
- Self reaming and tapping screws  
(unless options listed below are selected)

### Reduced opening force 4040XP Series closers

**CAUTION!** Any manual door closer, including those certified by BHMA to conform to ANSI Standard A156.4, that is selected, installed and adjusted based on ADA or other reduced opening force requirements may not provide sufficient power to reliably close and latch a door.

Refer to Automatic Operators catalog for information on systems that meet reduced opening force requirements without effecting closing power.

	Door width	36"	42"	48"
	8.5* lbs.	4040XP	4040XP	4040XP
	5.0* lbs.	4040XP	4040XP	4040XP

\* Maximum opening force.